



**Thermo Scientific**  
Class II Biological Safety Cabinets  
and Laminar Airflow Benches



# protection

that never takes a day off

**Thermo**  
SCIENTIFIC

# protection

that never takes a day off

With Thermo Scientific biological safety cabinets, the certified performance and protection you receive on Day 1 stays with you every day. Not true with ordinary cabinets.

The difference is our design: SmartFlow™ technology features dual-DC motors to automatically balance the cabinet inflow and downflow air velocities in real time – even as the filters load. That means outstanding user and sample protection you never have to think about. Plus, our Digital Airflow Verification (DAVe) alarm signals any out-of-spec conditions, for added assurance.

With our proven reliability, ergonomics and energy efficiency, the ideal choice is the one you can trust completely. And not just on Day 1.



## technology leadership

Technical advancements include:

1965

Our first line of clean-air products

1978

Our first NSF-certified BSC

1985

World's first TÜV-certified BSC

1993

World's first BSC with motorized front window and aerosol-tight sealing

## Global market vision

Our design philosophy is grounded in compliance with current worldwide safety standards.

## Quality built, premium features

With outstanding reliability and quality, discover why laboratories around the globe rely on Thermo Scientific BSCs every day.



1995

LNE-certified BSC units available

1996

DIN 12980-certified BSC for cytotoxic drugs

2002

World's first BSC with innovative brushless dual-DC motor technology (Herasafe KS™ BSC)

2007

Launch of the energy efficient MSC-Advantage BSC

2011

Launch of Thermo Scientific BSC with SmartPort tubing organizer

2013

Launch of Thermo Scientific Heraguard ECO laminar airflow bench with DC motor technology

## Thermo Scientific Class II Biological Safety Cabinets

- Personnel and sample protection with outstanding airflow and filter technology
- Extremely comfortable ergonomic design promotes safe working habits
- Maximized energy efficiency due to dual DC motors for reduced environmental impact and cost savings\*

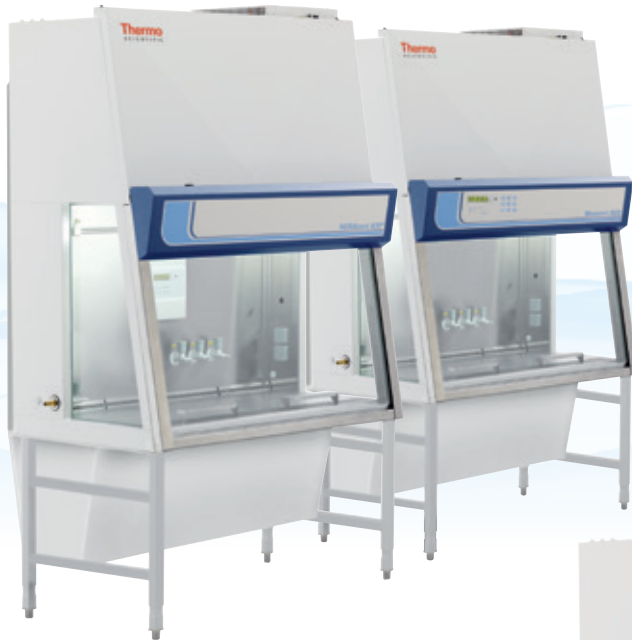

Thermo Scientific Herasafe KSP  
Thermo Scientific Maxisafe 2020  
Triple-filter Class II Biological Safety Cabinets



Thermo Scientific Herasafe KS  
Thermo Scientific Safe 2020  
Class II Biological Safety Cabinets

\*Based on data from internal testing and The University of Michigan Field Study, published in American Biotechnology Laboratory.

Not all BSCs are manufactured to the same safety standards. Our design philosophy is grounded in compliance with the recognized worldwide safety standards, because your work cannot compromise on safety. Our biological safety cabinets are subjected to all the following certifications:



### EN 12469

Our Class II biological safety cabinets are independently tested and certified to EN 12469 standard for Class II biological safety cabinets by TÜV Nord, a leading testing agency in Europe.

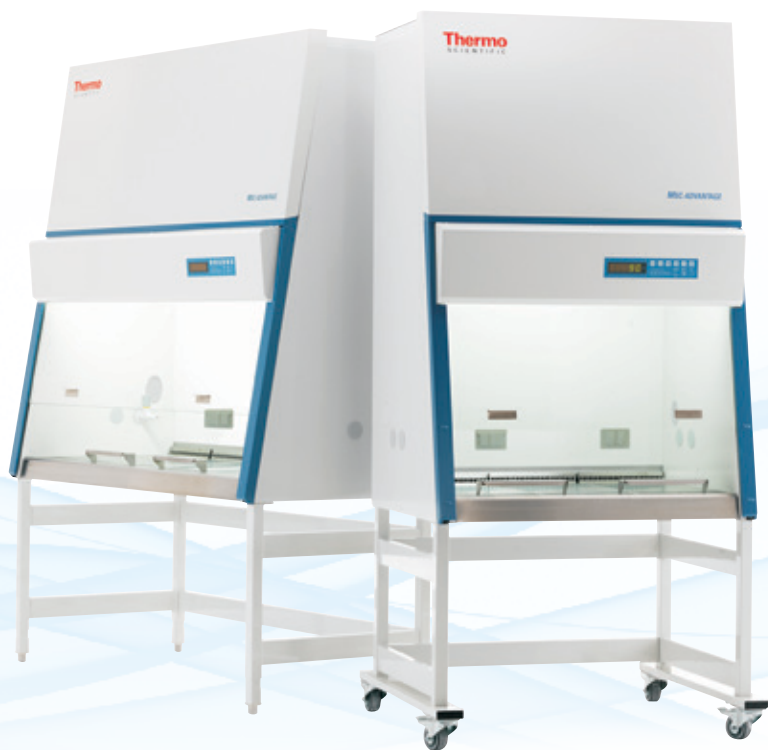

Thermo Scientific MSC-Advantage  
Class II Biological Safety Cabinets



NEW Thermo Scientific  
Heraguard ECO\*  
Laminar Flow Benches

#### Laminar Flow Benches available with

- Maximized energy efficiency due to DC motors for reduced environmental impact and cost savings\*
- Outstanding protection to preserve sample integrity
- Clean air conditions that provide strong results
- Ultimate ease of use for efficient work practices

\*Due to DC motors, Heraguard ECO clean benches use less energy to operate so there is less heat emitted into the lab than traditional AC motor clean benches. Based on data from internal testing and The University of Michigan Field Study, published in American Biotechnology Laboratory



#### EN 12469

Herasafe KS 1.2 m cabinet and MSC-Advantage 0.9 m and 1.2 m cabinets are independently tested and certified to EN 12469 by LNE, a leading testing agency in France.



#### DIN 12980

Herasafe KSP and Maxisafe 2020 cabinets with single piece worktops are independently tested and certified to the DIN 12980 standard "Safety Cabinets for Handling Cytotoxic Substances", for applications requiring the highest personal, product and environmental protection.

# outstanding performance

## for every application



Types of Protection	Sample	
	Operator	
	Environmental	
Recommended Applications	Cross-contamination	
	Tissue culture	
	Biosafety level 1	
	Biosafety level 2	
	Biosafety level 3	
Features	Highly active compounds, including CMR compounds and cytotoxics	
	Prions	
	Efficiency	Low-energy DC motors for operational cost savings and low heat emission
		Automated reduced flow mode for enhanced energy efficiency (Night Set-Back Mode)
		Long-life DC motors
	Containment	Automatic airflow balancing for safety in between certifications (SmartFlow)
		Real-time monitoring of HEPA filter efficiency (SmartFlow indicator / PER factor)
		Night Set-Back Mode (maintains sterility)
		Timed UV system for long bulb life
		Real-time airflow alarms to notify user of impaired safety
	Convenience	Aerosol-tight sealing front window
		Easy access to interior of front sash for cleaning, without tools
		Motorized front window for finger-tip opening and closing
316 stainless steel interior for enhanced resistance to corrosion		
304 stainless steel work surface		
Transparent side windows to maximize light and visibility inside the cabinet		
Comfort	Smart Clean	
	Smart Clean Plus	
	Forearm support armrest design to maximize comfort	
	Angled sash to encourage natural posture	
	Frameless front sash for maximum visibility	



**Herasafe KSP / Maxisafe 2020**  
(See page 10)

**Herasafe KS / Safe 2020**  
(See page 14)

**MSC-Advantage**  
(See page 18)

**Heraguard ECO**  
(See page 30)

	Herasafe KSP / Maxisafe 2020 (See page 10)	Herasafe KS / Safe 2020 (See page 14)	MSC-Advantage (See page 18)	Heraguard ECO (See page 30)
	•	•	•	•
	•	•	•	
	•	•	•	
	•	•	•	•
	•	•	•	•
	•	•	•	
	•	•	•	
	•	•	•	
	•	•	•	
	•	•	•	
	•	•	•	
	•	•	•	
	•	•	•	
	•	•	•	
	•	•	•	
	•	•	•	•
	•	•	•	
	•	•	•	
	•	•	•	•
	•	•	•	
	•	•	•	•
	•	•	•	
	•	•	•	
	•	•	•	
	•	•	•	
	•	•	•	
	•	•	•	
	•	•	•	
	•	•	•	
	•	•	•	
	•	•	•	•
	•	•	•	
	•	•	•	
	•	•	•	•
	•	•	•	

The right cabinet for you

# innovations in containment and efficiency

## Brushless DC motors

In 2002, we pioneered the first brushless DC motor technology. Now available in our full line of BSCs and the Heraguard™ ECO clean benches, our DC motor advancements have redefined and transformed BSC energy efficiency, safety, performance and reliability.

### Use less energy, reduce costs

**DC motors use less energy to operate, so there is less heat emitted back into the lab** – delivering better comfort and lower air conditioning costs. On average, our BSCs use 75% less energy than traditional AC motor cabinets.\*

### Exceptional reliability

Our dual-motor BSC is designed to have an expected lifetime of more than 11 years – at least double the life of traditional AC motor and single DC motor systems based on comparison to previous models – resulting in significant savings on motor replacements over the life of the cabinet.

### Long filter life

Larger mini-pleat H14 HEPA filters and balanced airflow, coupled with eight-inch work aperture, results in higher filtration efficiency and longer filter when compared to previous models.



## Check the watts!

Thermo Scientific biological safety cabinets have outstanding in operational cost efficiency with energy consumption as low as 150W.\*

### Optimizing total cost of operation

Thermo Scientific SmartFlow airflow compensation and balanced filters have led to safer BSCs that are easier to use and significantly less costly to operate.\*\*

### The more you use it, the more you save!

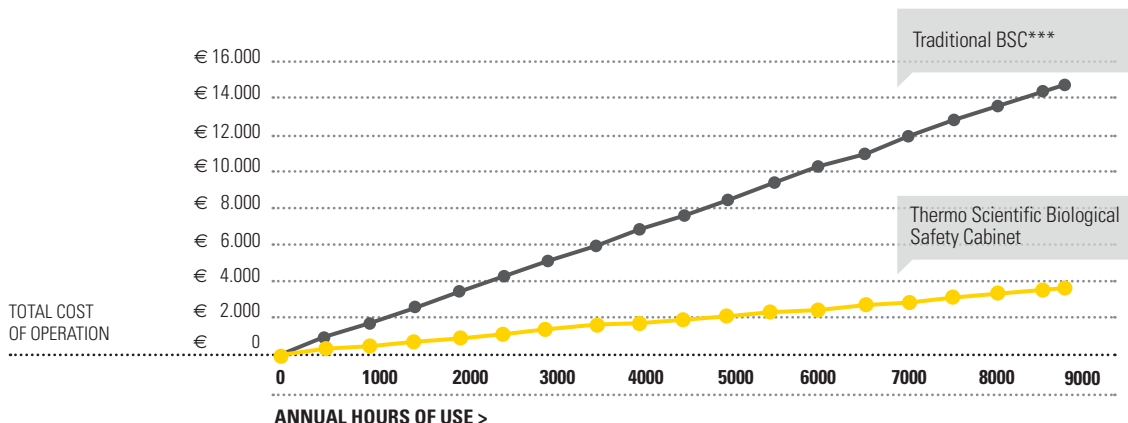

\* Based on data from internal testing and The University of Michigan Field Study of Class II Biological Safety Cabinet Energy Consumption Costs, published in American Biotechnology Laboratory.

\*\* Compared to previous models.

\*\*\* Comparison based on 15 year life of 1.2 m wide biological safety cabinets and 2011 average costs of energy and cooling in the EuroZone. "Traditional BSC" estimates based on published product specifications for readily available BSCs using AC motor technology.



## Advanced design for peace of mind

- H14 HEPA filters (EN 1822) increase filtration efficiency at 99.995% of mpps
- Solid plenums for long life and lasting containment

### SmartFlow™ ensures safety

#### Unique airflow system takes safety and containment to new levels

- Smart DC motors monitor and control fan speed in real time to maintain constant airflow during filter loading or temporary obstruction.
- Exclusive to our BSCs, independent supply and exhaust blowers automatically balance both the downflow and inflow velocities to maintain both operator and sample protection.

### Digital Airflow Verification (DAVe) validates protection

#### Monitoring system alerts user when containment is compromised

- Independent sensors detect pressure changes across the exhaust and downflow plenums.
- Alarm is designed to signal when a 20% change in inflow/exhaust or downflow occurs.
- Airflow velocities are displayed on the control panel for monitoring and recording.

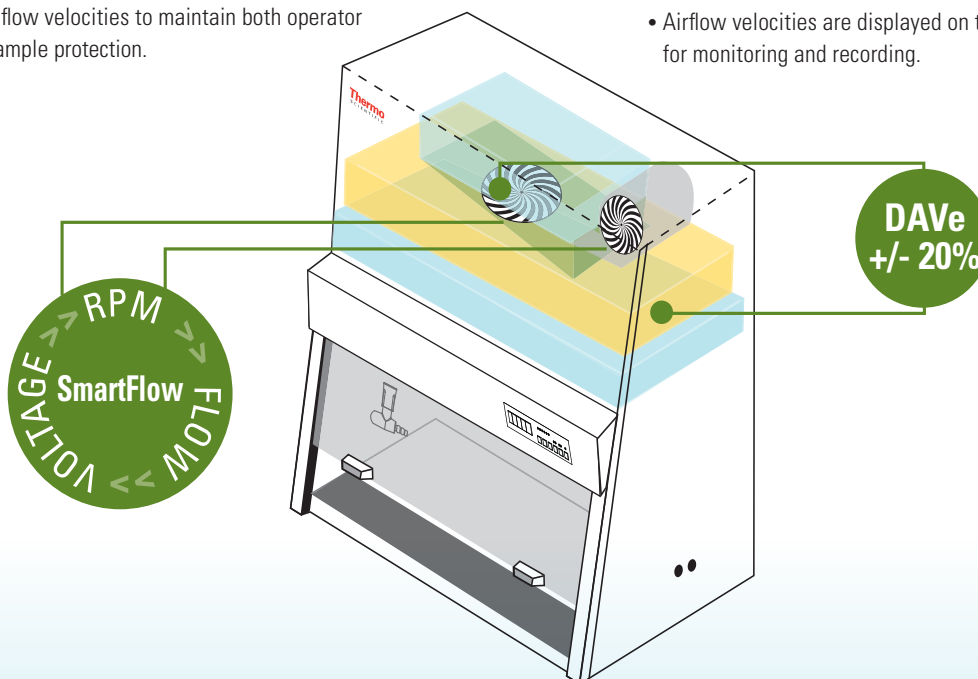

### SmartFlow Indicator / Performance Monitoring provides real-time information

#### Displays real-time information of overall cabinet status including operation safety and service requirements

- The performance factor is a figure from 0-100% and can be accessed by the user on the display.
- The SmartFlow indicator (MSC-Advantage) simply changes from green to red.

### Night Set-Back Mode saves energy, maintains sterility

#### When the front sash is closed, our intelligent speed control automatically reduces blower speed

- Continuous airflow maintains a sterile working environment, even when the cabinet is not in use.
- Less air flows through the HEPA filters, extending filter life and decreasing energy consumption.
- Night Set-Back is significantly more energy efficient than similar features on competing biological safety cabinets.
- Night Set-Back Mode further reduces the heat emission.

# designed for comfort and convenience

Thermo Scientific BSCs offer an efficient workspace, improved ergonomics, and added conveniences that provide the user greater productivity and ultimately, better laboratory results.

## Ergonomic design

- Sloped front window is designed to reduce user fatigue
- Bright open chamber improves visibility
- Quiet airflow design offers noticeably reduced noise level

## Ergonomically positioned arm rest

- Extends user reach inside cabinet
- Provides forearm support to reduce strain
- Ensures clothing does not block front air intake grill
- Supports work midway between rear and front grill

## Thermo Scientific Ergolign saddle stool

- Exclusive seat design reduces back strain and fatigue
- Clean room-ready, with 0.5  $\mu\text{m}$  filtration system within the seat, trapping 99.9% of particles exhausted, fulfilling Class 100 requirements
- Fully adjustable seat height and tilt, using a patented icon plate mechanism
- Stores easily under the BSC to save floor space

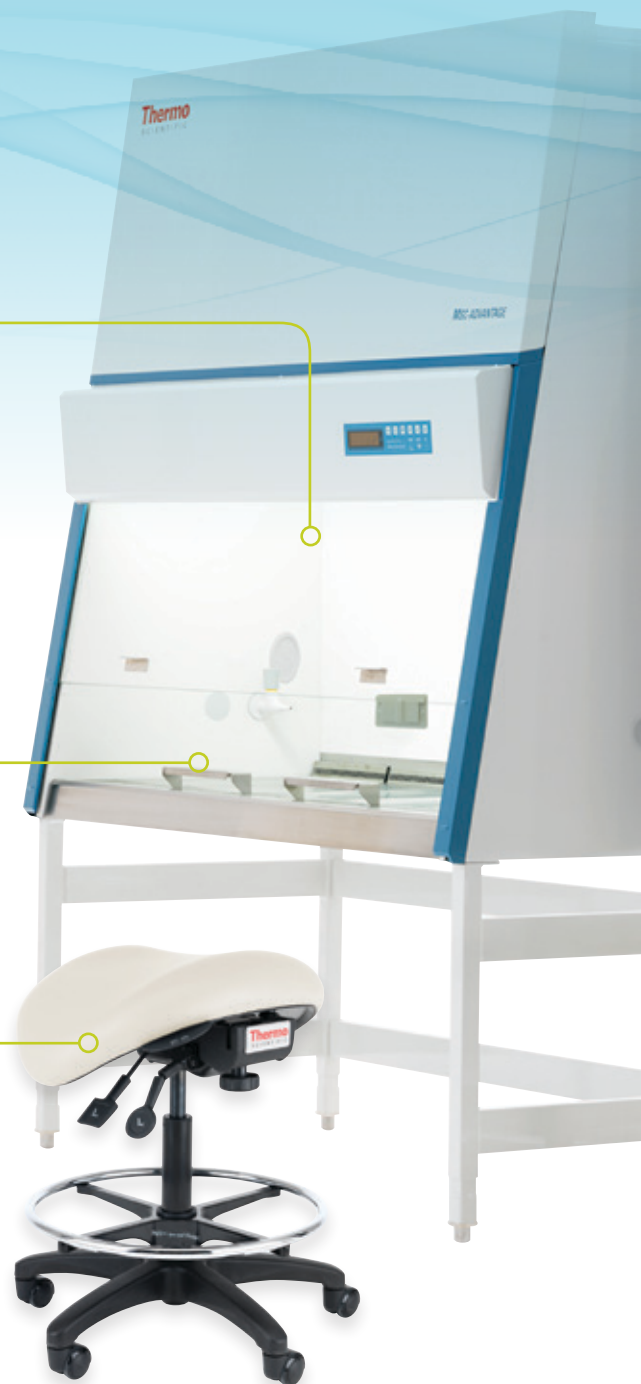

# smarter design

## Work smarter, more efficiently

- Easy to use
- Easy to clean without dismantling cabinet
- Extremely quiet to operate



### SmartPort™ convenience

Clean and safe routing for vacuum tubing and cables through the side of the BSC for improved organization and work efficiency.



### SmartClean™ window design

Our unique window design easily lowers for thorough cleaning of inner surfaces and protects operator by maintaining inflow, even when the window is lowered.

### SmartClean Plus

Fully open, front-hinged window design allows convenient posture for thorough, easy cleaning and disinfection, with full access to interior.

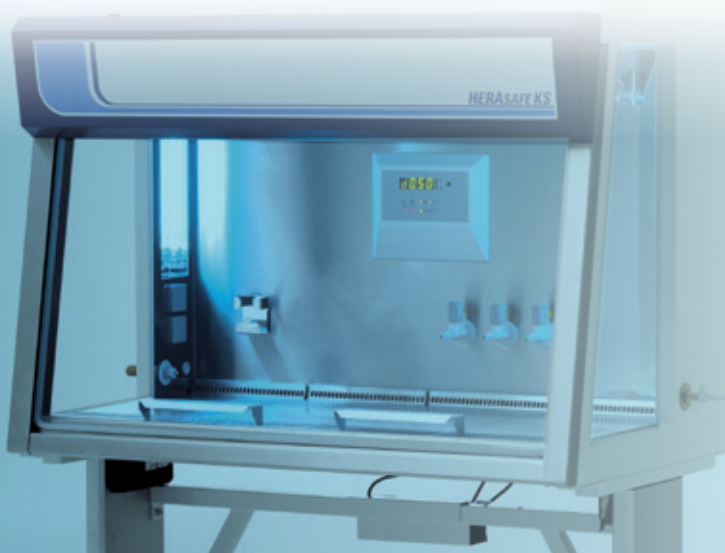

### Worry-free decontamination

All units offer an optional UV light that is programmable from 30 minutes to 24 hours in 30-minute increments, extending bulb life and saving energy.

# outstanding protection, comfort and performance

for CMR (carcinogenic, mutagenic  
or toxic to reproduction) compounds

## Thermo Scientific Herasafe KSP and Maxisafe 2020 units

Robust construction and excellent ergonomic design combined with significantly more effective air filtration than regular Class II biological safety cabinets, resulting in exceptional protection for personnel, sample and environment.

### Containment

- **SmartFlow design** automates airflow compensation and balancing
- **Digital Airflow Verification (DAVe)** alerts user to compromised containment
- **H14 HEPA filters** remove airborne contaminants
- **Performance factor safety indicator** displays performance status
- **Cross beam UV disinfection system** (option) illuminates entire work area without shadows
- **SampleGuard aerosol-tight window sealing** for added sample protection and easy sealing for fumigation

### Comfort

- **Reduced noise level** enhances user focus
- **10° sloped front** for exceptional comfort and ergonomics
- **Spacious work area** with comfortable armrests
- **Transparent side glass windows** maximize light and visibility

### Convenience

- **SmartClean Plus** hinged front window design for easy cleaning
- **Intuitive eye-level display** with handheld controls for at-a-glance monitoring (KSP)
- **Motorized frameless window sash ensures safe sash** height at the push of a button
- **Scratch-resistant, 1.4404 / 316L stainless steel work surfaces** are available as single or segmented modules and are easy to clean or autoclave
- **Programmable cross beam UV light** extends bulb life and saves energy

### Efficiency

- **DC motors** offer low energy consumption and greater than 11 years of use
- **Night Set-Back Mode** reduces airflow to 30% during low-usage periods
- **Long filter life\***
- **Long UV bulb life\***  
Programmable UV light extends bulb life

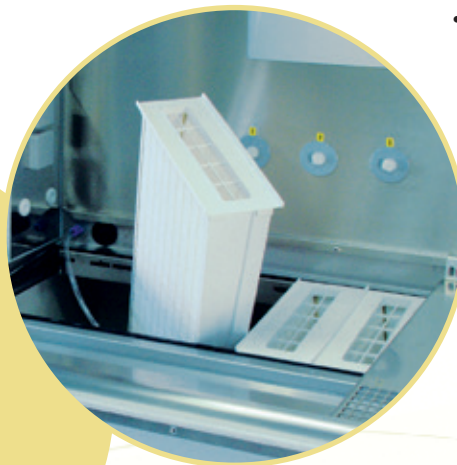

Interlocking H14 HEPA filters under the work surface provide easy and safe HEPA filter changes in the work area under safe negative pressure

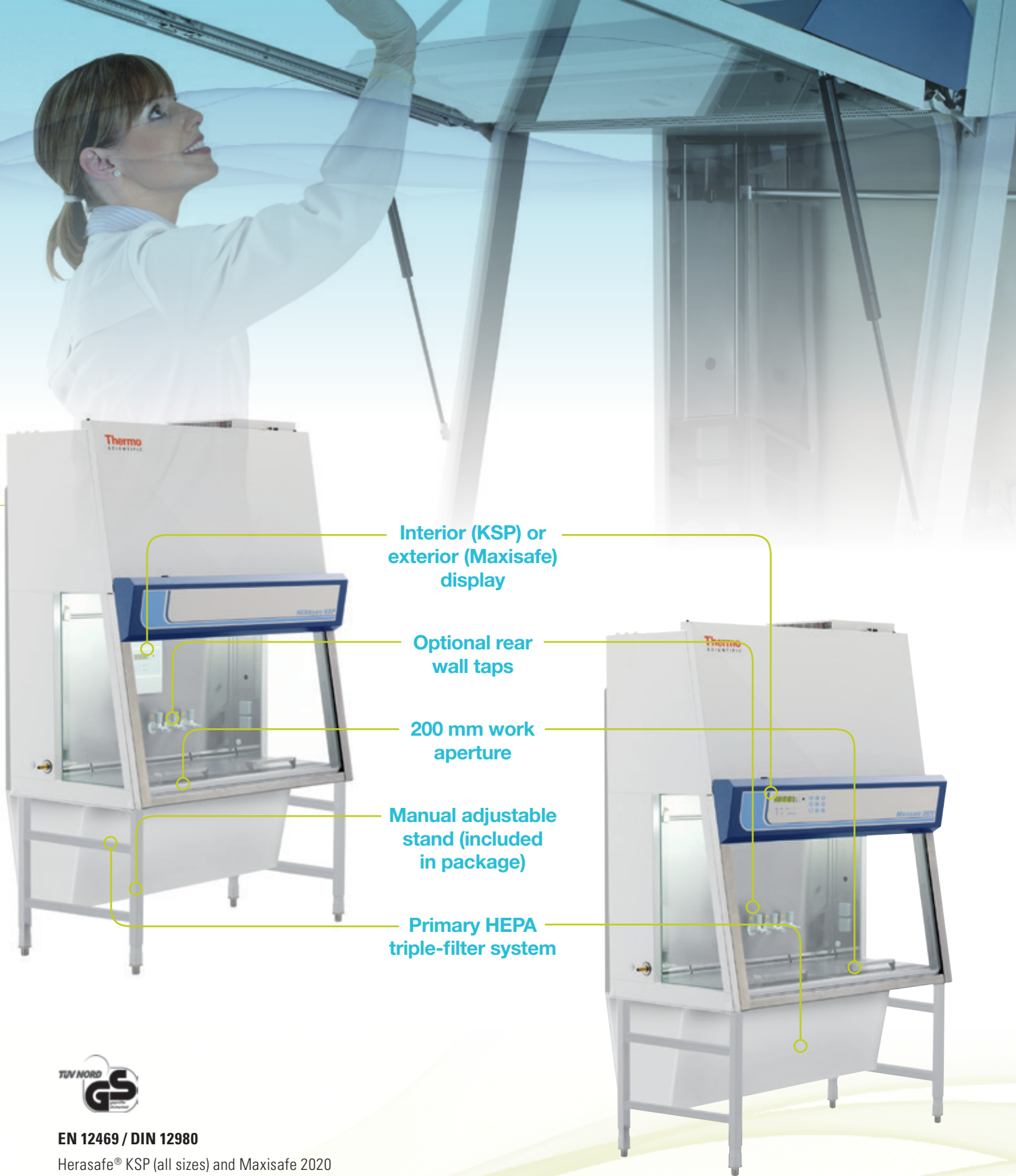

Interior (KSP) or exterior (Maxisafe) display

Optional rear wall taps

200 mm work aperture

Manual adjustable stand (included in package)

Primary HEPA triple-filter system



**EN 12469 / DIN 12980**

Herasafe® KSP (all sizes) and Maxisafe 2020 1.2 and 1.8 m sizes cabinets with single piece worktops are independently tested and certified to the DIN 12980 standard "Safety Cabinets for Handling Cytotoxic Substances", requiring the highest personnel, product and environmental protection.

# Thermo Scientific Herasafe KSP and Maxisafe 2020 BSCs

DIN 12980 recommends the use of thimble duct with the triple-filter Class II BSC units. Herasafe KSP/Maxisafe 2020, with single piece worktops are certified to this standard.

## Triple-filter BSCs provide

- A minimum ISO Class 5 air quality in the work area
  - 100,000 x better filtration efficiency than regular Class II biological safety cabinets with the use of a unique triple filter design
  - Safe filter change in the cabinet work area under negative pressure
  - A more ergonomic and comfortable work environment than traditional isolators
  - Easy clean system ideal for cleanroom/ GMP installations.
  - Extensive certification: EN 12469 and DIN 12980
- Available as recirculating, thimble and direct duct exhaust transition.
  - Can be used and incorporated in place of traditional isolators when sited in the correct environment.

Airflow inside a Triple-Filter Class II BSC

- Unfiltered air
- HEPA filtered clean air

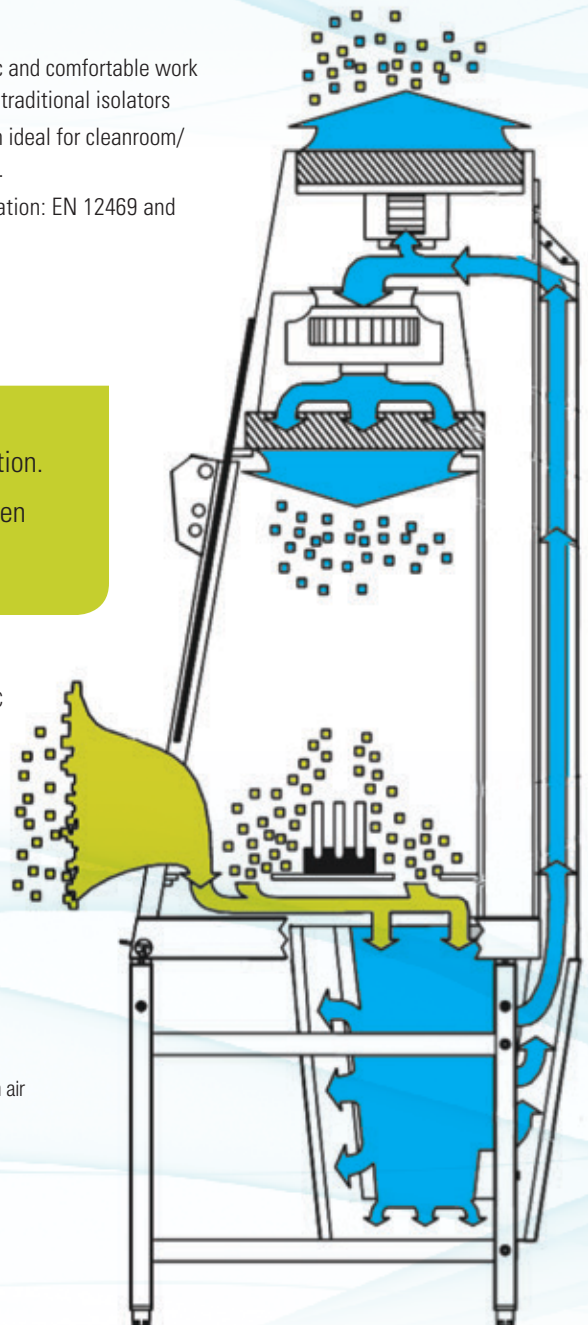



# Thermo Scientific Herasafe KSP and Maxisafe 2020 BSCs

Size / Internal Width	0.9 m	1.2 m	1.5 m	1.8 m
<b>Herasafe KSP Ordering Information</b>	51023606	51023607	51023608	51023609
<b>MaxiSafe 2020 Ordering Information</b>	51026651	51026652	51026653	51026654

## Dimensions

	mm	1000 x 1586 x 870	1300 x 1586 x 870	1600 x 1586 x 870	1900 x 1586 x 870
Exterior dimensions (without stand) <sup>1,2</sup> W x H x D	mm	1000 x 1586 x 870	1300 x 1586 x 870	1600 x 1586 x 870	1900 x 1586 x 870
Interior dimensions W x H x D	mm	900 x 780 x 630	1200 x 780 x 630	1500 x 780 x 630	1800 x 780 x 630
Shipping dimensions <sup>3</sup> W x H x D	mm	1110 x 1760 x 925	1410 x 1760 x 925	1710 x 1760 x 925	2010 x 1760 x 925
Working height of front window	mm	200			
Maximum opening height of front window	mm	773			

## Weight

	kg	200	240	280	330
Net weight	kg	200	240	280	330
Shipping weight <sup>3</sup>	kg	220	265	310	365
Max. load capacity of one-piece work surface	kg	50	50	50	50
Max. load capacity of single segmented work surface per 30 cm segments <sup>4</sup>	kg	25	25	25	25

## Electrical Data

Voltage	V	230			
Frequency	Hz	50/60			
Protection class		I / IP 20			

## Filter Specification

H14 HEPA EN 1822, 99.995% MPPS (most penetrating particle size)

## Certifications to EN 12469 / DIN 12980

Herasafe KSP	TÜV	TÜV	TÜV	TÜV
MaxiSafe 2020		TÜV		TÜV

## Ergonomics and Utilities

Lighting power	lx	>800	>850	>1250	>1300
Receptacles <sup>5</sup>		2 sockets on each side wall			
Service valves		Up to 4 may be installed through access ports (2 on each side) Up to 6 more may be factory installed on rear wall (optional)			

## Other Specifications

	dB (A)	<56	<56	<58	<58
Noise level <sup>6</sup>	dB (A)	<56	<56	<58	<58
Energy consumption, operating set point <sup>7</sup>	W	200	240	305	420
Energy consumption, reduced flow mode	W	40	40	70	70
Normal heat output in operation mode (non-vented)	BTU/hr	682	819	1041	1433
Reduced flow heat output (lights off, non-vented)	BTU/hr	136	136	239	239
Exhaust / inflow air volume	m <sup>3</sup> /h	288	386	483	580
Ducting volume requirement, thimble connection	m <sup>3</sup> /h	375	501	628	754

- 1 Exterior height to top of exhaust HEPA filter for clearance purposes is 1500 mm
- 2 All Herasafe KSP and Maxisafe 2020 models include a manual adjustable height base stand
- 3 Export packaging dimensions and weight upon request
- 4 The total load on overall working surface must not exceed 50 kg
- 5 The receptacles have a load capacity of up to 5 A and are protected with T 5 A fuses. When all receptacles are in use simultaneously they must not exceed the maximum total load capacity of 5 A
- 6 Tested according to EN 12469
- 7 Clean filters, fans operating at nominal set point, interior lighting activated

# outstanding comfort and ergonomic design

## Thermo Scientific Herasafe KS and Safe 2020 units

Featuring an advanced design for easy operation and maximum safety, Herasafe KS and Safe 2020 BSCs are used wherever sample and user protection is paramount.

### Containment

- **SmartFlow design** automates airflow compensation and balancing
- **Digital Airflow Verification (DAVe)** alerts user to compromised containment
- **H14 HEPA filters** remove airborne contaminants
- **Performance factor safety indicator** displays performance status
- **Cross beam UV disinfection system** illuminates entire work area without shadows
- **SampleGuard aerosol-tight window sealing** for added sample protection and easy sealing for fumigation

### Comfort

- **Reduced noise level** enhances user focus
- **10° sloped front** for exceptional comfort and ergonomics
- **Spacious work area** with comfortable armrests
- **Transparent side glass windows** maximize light and visibility

### Convenience

- **SmartClean Plus** hinged front window design for easy cleaning
- **Motorized frameless window sash** ensures safe sash height at the push of a button
- **Scratch resistant, 1.4404 / 316L stainless steel work surfaces** are available as single or segmented modules and are easy to clean or autoclave
- **Programmable cross beam UV light** extends bulb life and saves energy

### Indicator and Operating Panel

#### Airflow Read-Out and Hour Counter:

Displays realtime performance data, including downflow velocities, hours of operation and time

#### DAVe Airflow Indicator:

Audible and visual alarms indicate when airflow is safe or restricted

#### Performance Factor:

Displays the performance status

#### Front Window Status:

Visual and audible alarm indicates whether front window is in correct working position

#### Night Set-Back Indicator:

Displays reduced speed operation when front window is closed

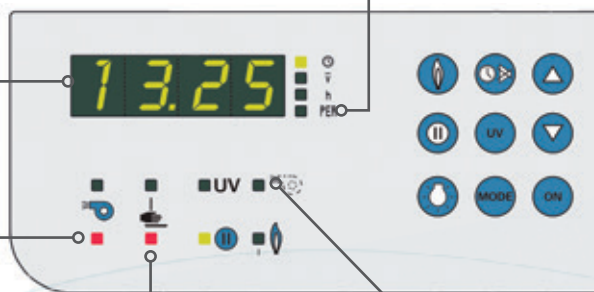



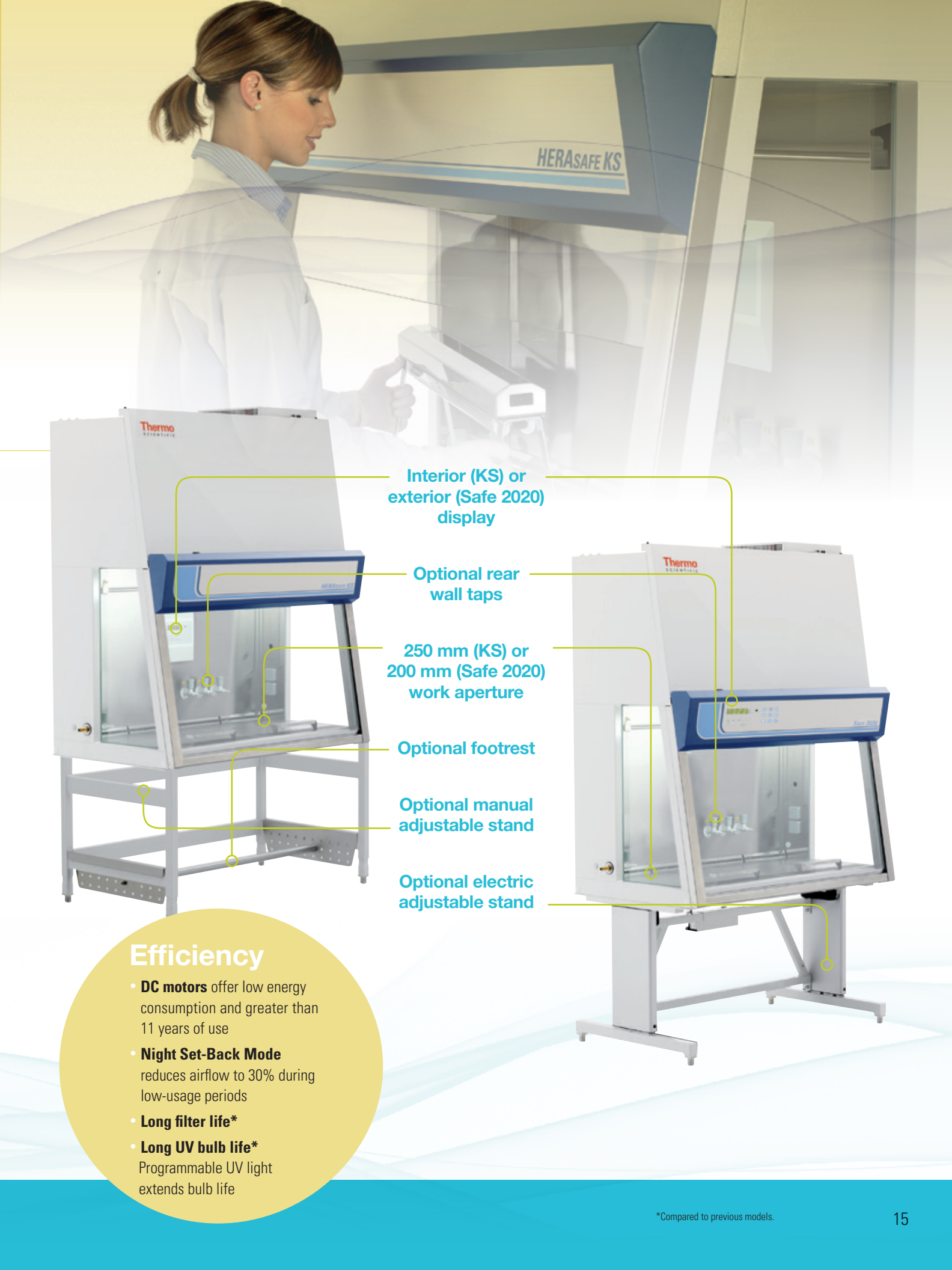

Interior (KS) or exterior (Safe 2020) display

Optional rear wall taps

250 mm (KS) or 200 mm (Safe 2020) work aperture

Optional footrest

Optional manual adjustable stand

Optional electric adjustable stand

## Efficiency

- **DC motors** offer low energy consumption and greater than 11 years of use
- **Night Set-Back Mode** reduces airflow to 30% during low-usage periods
- **Long filter life\***
- **Long UV bulb life\***  
Programmable UV light extends bulb life

\*Compared to previous models.

# Thermo Scientific BSC customer projects support

Thermo Scientific customer projects group can offer specific solutions tailored to your unique application needs.

Customization is limited to modifications of our standard product offering on the following cabinets:

- Herasafe KSP and Maxisafe 2020 Triple-filter Class II Biological Safety Cabinets
- Herasafe KS and Safe 2020 Class II Biological Safety Cabinets
- Heraguard ECO Laminar Flow Benches

Customization options can include:

- Particle monitoring
- Further work surface options
- Flat screen monitors in rear walls
- Adaptation to GMP environments – and many more

To learn more about how we can tailor our units to fit your unique needs contact your sales representative.

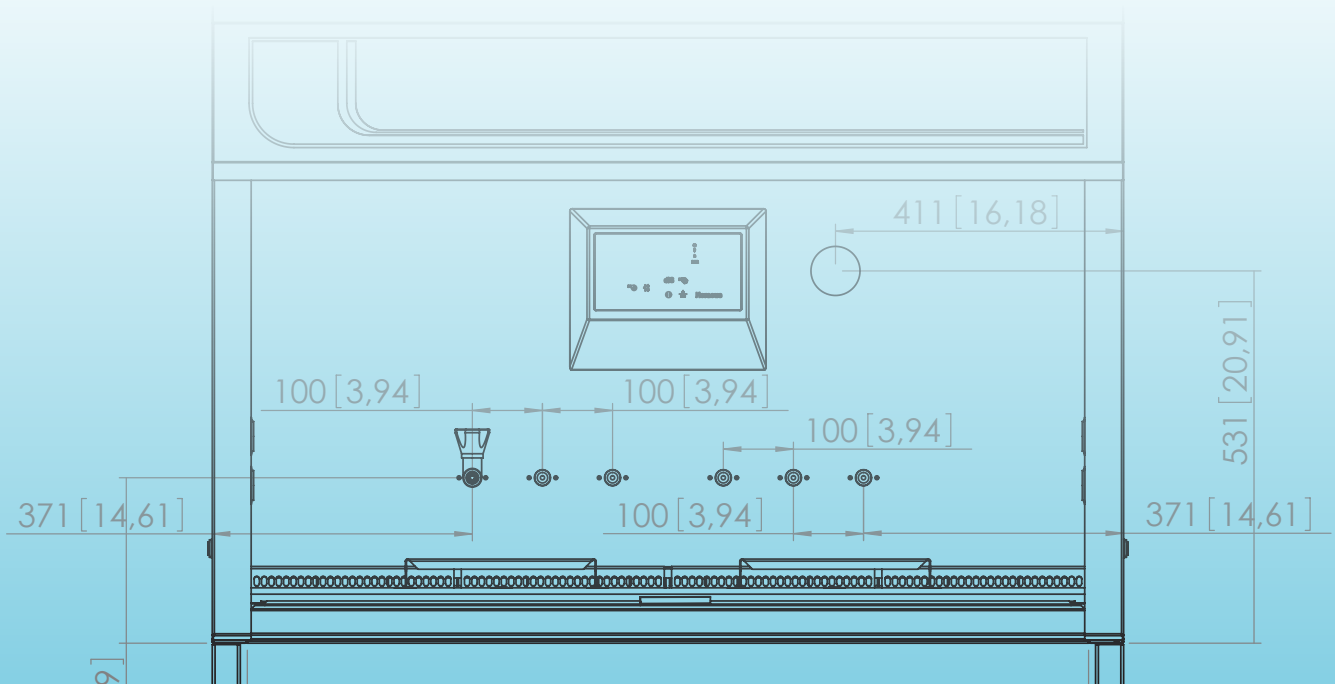

# Thermo Scientific Herasafe KS and Safe 2020 BSCs



Size / Internal Width	0.9 m	1.2 m	1.5 m	1.8 m
<b>Herasafe KS Ordering Information</b>	51022481	51022482	51022483	51022484
<b>Safe 2020 Ordering Information</b>	51026637	51026638	51026639	51026640

### Dimensions

	mm	1000 x 1586 x 799	1300 x 1586 x 799	1600 x 1586 x 799	1900 x 1586 x 799
Exterior dimensions <sup>1</sup> W x H x D	mm	1000 x 1586 x 799	1300 x 1586 x 799	1600 x 1586 x 799	1900 x 1586 x 799
Interior dimensions W x H x D	mm	900 x 780 x 630	1200 x 780 x 630	1500 x 780 x 630	1800 x 780 x 630
Shipping dimensions <sup>2</sup> W x H x D	mm	1110 x 1760 x 925	1410 x 1760 x 925	1710 x 1760 x 925	2010 x 1760 x 925
Herasafe KS – working height of front window	mm			250	
Safe 2020 – working height of front window	mm			200	
Maximum opening height of front window	mm			773	

### Weight

	kg	170	200	230	280
Net weight	kg	170	200	230	280
Shipping weight <sup>2</sup>	kg	190	225	260	315
Max. load capacity of one-piece work surface	kg	50	50	50	50
Max. load capacity of single segmented work surface per 30 cm segments <sup>3</sup>	kg	25	25	25	25

### Electrical Data

Voltage	V			230	
Frequency	Hz			50/60	
Protection class				I / IP 20	

### Filter Specification

H14 HEPA EN 1822, 99.995% MPPS

### Certifications to EN 12469

Herasafe KS	TÜV	TÜV, LNE	TÜV	TÜV
Safe 2020		TÜV		TÜV

### Ergonomics and Utilities

Lighting power	lx	>800	>850	>1250	>1300
Receptacles <sup>4</sup>			2 sockets on each side wall		
Service valves		Up to 4 may be installed through access ports (2 on each side) Up to 6 more may be factory installed on rear wall (optional)			

### Herasafe KS Specifications

	dB (A)	<58	<58	<60	<60
Noise level <sup>5</sup>	dB (A)	<58	<58	<60	<60
Energy consumption, operating set point <sup>6</sup>	W	170	210	275	350
Energy consumption, reduced flow mode	W	40	40	70	70
Normal heat output in operation mode (non-vented)	BTU/hr	580	717	938	1194
Reduced flow heat output (lights off, non-vented)	BTU/hr	136	136	239	239
Exhaust / inflow air volume	m <sup>3</sup> /h	366	490	613	737
Ducting volume requirement, thimble connection	m <sup>3</sup> /h	476	637	797	958

### Safe 2020 Specifications

	dB (A)	<56	<56	<58	<58
Noise level <sup>5</sup>	dB (A)	<56	<56	<58	<58
Energy consumption, operating set point <sup>6</sup>	W	160	200	265	340
Energy consumption, reduced flow mode	W	40	40	70	70
Normal heat output in operation mode (non-vented)	BTU/hr	546	682	904	1161
Reduced flow heat output (lights off, non-vented)	BTU/hr	136	136	239	239
Exhaust / inflow air volume	m <sup>3</sup> /h	288	386	483	580
Ducting volume requirement, thimble connection	m <sup>3</sup> /h	375	501	628	754

- 1 Exterior height to top of exhaust HEPA filter for clearance purposes is 1500 mm
- 2 Export packaging dimensions and weight upon request
- 3 The total load on overall working area must not exceed 50 kg
- 4 The receptacles have a load capacity of up to 5 A and are protected with T 5 A fuses. When all receptacles are in use simultaneously they must not exceed the maximum total load capacity of 5 A
- 5 Tested according to EN 12469
- 6 Clean filters, fans operating at nominal set point, interior lighting activated

# optimized efficiency, safety and value

for advanced applications

## Thermo Scientific MSC-Advantage units

MSC-Advantage Class II biological safety cabinets combine safety, energy efficiency and value for today's laboratory.

### Containment

- **SmartFlow design** automates airflow compensation and balancing
- **Digital Airflow Verification (DAVe)** alerts user to compromised containment
- **H14 HEPA filters** remove airborne contaminants
- **SmartFlow indicator** displays performance status

### Comfort

- **Low noise level** enhances user focus
- **10° sloped front** for exceptional comfort and ergonomics
- **Spacious work area** with comfortable armrests
- **Increased light intensity** for a brighter work environment

### Convenience

- **SmartClean front window design**
- **Intuitive control panel** displays safety and performance data
- **SmartPort** organizes tubing and cables
- **Programmable UV light** extends bulb life and saves energy

### Intuitive Control Panel:

Displays valuable safety and performance data with constant read-out of downflow/inflow velocities

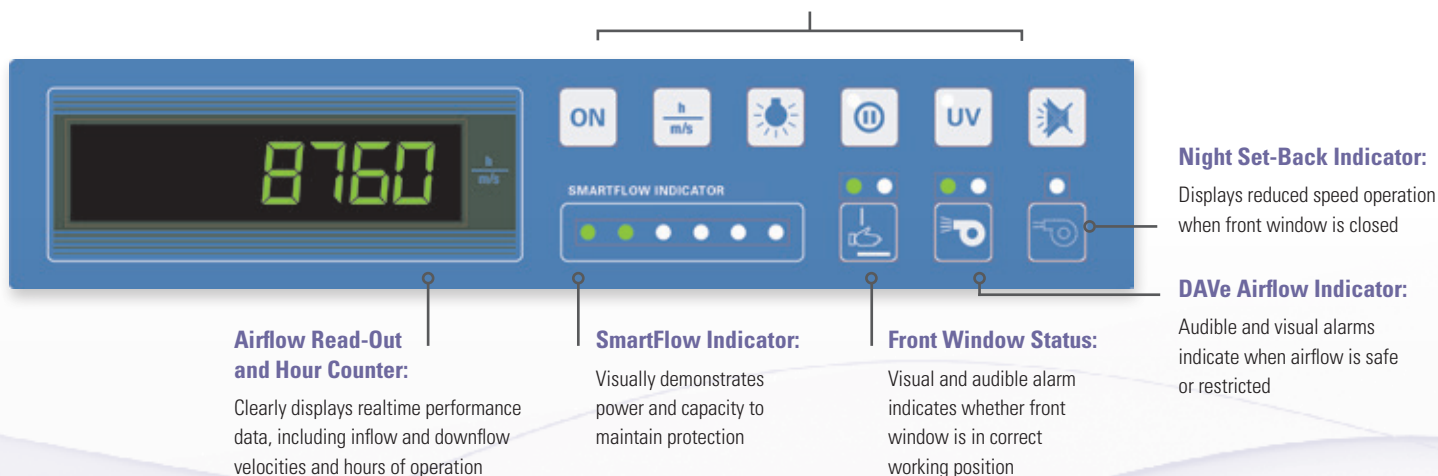



Intuitive control panel

Optional rear wall tubing clips

SmartPort convenience

Sloping front sash

200 mm work aperture

Optional hanging shelf

Optional adjustable stand

Optional Ergolign saddle stool

## Efficiency

- **DC motors** offer low energy consumption and greater than 11 years of use
- **Night Set-Back Mode** reduces airflow to 30% during low-usage periods
- **Long filter life\***
- **Long UV bulb life\***  
Programmable UV light extends bulb life

\*Compared to previous models.



# Thermo Scientific MSC-Advantage BSCs

Size / Internal Width		0.9 m	1.2 m	1.5 m	1.8 m
<b>Catalog Number</b>		51028225	51025411	51028226	51025413
<b>Dimensions</b>					
Exterior dimensions <sup>1</sup> W x H x D	mm	1000 x 1522 x 798	1300 x 1522 x 798	1600 x 1522 x 798	1900 x 1522 x 798
Interior dimensions W x H x D	mm	900 x 780 x 630	1200 x 780 x 630	1500 x 780 x 630	1800 x 780 x 630
Shipping dimensions <sup>2</sup> W x H x D	mm	1110 x 1730 x 925	1410 x 1730 x 925	1710 x 1730 x 925	2010 x 1730 x 925
Working height of front window	mm	200			
Maximum opening height of front window	mm	535			
<b>Weight</b>					
Net weight	kg	170	200	230	280
Shipping weight <sup>2</sup>	kg	190	225	265	315
Max. load capacity of single segmented work surface per 30 cm segments <sup>3</sup>	kg	25	25	25	25
<b>Electrical Data</b>					
Voltage	V	230			
Frequency	Hz	50/60			
Protection class		I / IP 20			
<b>Filter Specification</b>		H14 HEPA EN 1822, 99.995% MPPS			
<b>Certifications to EN 12469</b>		TÜV, LNE	TÜV, LNE	TÜV	TÜV
<b>Ergonomics and Utilities</b>					
Lighting power	lx	>800	>850	>1250	>1300
SmartPort		2 76 mm plugged cable ports, one on each side wall			
Receptacles <sup>4</sup>		2 sockets on right rear wall		2 sockets on right and left rear wall	
Service valves		Up to 4 may be installed through access ports (2 on each side)			
<b>Other Specifications</b>					
Noise level <sup>5</sup>	dB (A)	<55	<55	<59	<59
Energy consumption, operating set point <sup>6</sup>	W	150	200	280	340
Energy consumption, reduced flow mode	W	40	40	70	70
Normal heat output in operation mode (non-vented)	BTU/hr	512	682	955	1160
Reduced flow heat output (lights off, non-vented)	BTU/hr	136	136	239	239
Exhaust / inflow air volume	m <sup>3</sup> /h	292	389	486	583
Ducting volume requirement, thimble connection	m <sup>3</sup> /h	379	505	632	758

1 Exterior height to top of exhaust HEPA filter for clearance purposes is 1500 mm  
 2 Export packaging dimensions and weight upon request  
 3 The total load on overall working area must not exceed 50 kg  
 4 The receptacles have a load capacity of up to 5 A and are protected with T 5 A fuses. When all receptacles are in use simultaneously they must not exceed the maximum total load capacity of 5 A  
 5 Tested according to EN 12469  
 6 Clean filters, fans operating at nominal set point, interior lighting activated

# Ordering information

## Biological Safety Cabinets

All BSC basic models are listed below

### Herasafe KSP

51023606	Herasafe KSP9 Class II Triple Filter Biological Safety Cabinet, external width 1000 mm, internal width 900 mm, 230V, 50Hz
51023607	Herasafe KSP12 Class II Triple Filter Biological Safety Cabinet, external width 1300 mm, internal width 1200 mm, 230V, 50Hz
51023608	Herasafe KSP15 Class II Triple Filter Biological Safety Cabinet, external width 1600 mm, internal width 1500 mm, 230V, 50Hz
51023609	Herasafe KSP18 Class II Triple Filter Biological Safety Cabinet, external width 1900 mm, internal width 1800 mm, 230V, 50Hz

### Maxisafe 2020

51026651	Maxisafe 2020 0.9 Class II Triple Filter Biological Safety Cabinet, external width 1000 mm, internal width 900 mm, 230V, 50Hz
51026652	Maxisafe 2020 1.2 Class II Triple Filter Biological Safety Cabinet, external width 1300 mm, internal width 1200 mm, 230V, 50Hz
51026653	Maxisafe 2020 1.5 Class II Triple Filter Biological Safety Cabinet, external width 1600 mm, internal width 1500 mm, 230V, 50Hz
51026654	Maxisafe 2020 1.8 Class II Triple Filter Biological Safety Cabinet, external width 1900 mm, internal width 1800 mm, 230V, 50Hz

### Herasafe KS

51022481	Herasafe KS9 Class II Biological Safety Cabinet, external width 1000 mm, internal width 900 mm, 230V, 50Hz
51022482	Herasafe KS12 Class II Biological Safety Cabinet, external width 1300 mm, internal width 1200 mm, 230V, 50Hz
51022483	Herasafe KS15 Class II Biological Safety Cabinet, external width 1600 mm, internal width 1500 mm, 230V, 50Hz
51022484	Herasafe KS18 Class II Biological Safety Cabinet, external width 1900 mm, internal width 1800 mm, 230V, 50Hz

### Safe 2020









51026637	Safe 2020 0.9 Class II Biological Safety Cabinet, external width 1000 mm, internal width 900 mm, 230V, 50Hz
51026638	Safe 2020 1.2 Class II Biological Safety Cabinet, external width 1300 mm, internal width 1200 mm, 230V, 50Hz
51026639	Safe 2020 1.5 Class II Biological Safety Cabinet, external width 1600 mm, internal width 1500 mm, 230V, 50Hz
51026640	Safe 2020 1.8 Class II Biological Safety Cabinet, external width 1900 mm, internal width 1800 mm, 230V, 50Hz

### MSC-Advantage

51028225	MSC-Advantage 0.9 Class II Biological Safety Cabinet, external width 1000 mm, internal width 900 mm, 230V, 50Hz
51025411	MSC-Advantage 1.2 Class II Biological Safety Cabinet, external width 1300 mm, internal width 1200 mm, 230V, 50Hz
51028226	MSC-Advantage 1.5 Class II Biological Safety Cabinet, external width 1600 mm, internal width 1500 mm, 230V, 50Hz
51025413	MSC-Advantage 1.8 Class II Biological Safety Cabinet, external width 1900 mm, internal width 1800 mm, 230V, 50Hz

## Receptacle Options

Country configurations are available to ensure the correct line cord and internal receptacle are shipped with the cabinet. Standard version for cabinets is Schuko.

			Herasafe KSP / Maxisafe 2020	Herasafe KS / Safe 2020	MSC-Advantage	Factory Installed	Field Installed
51900300	 Switzerland		•	•	•	•	
51900303	 UK		•	•	•	•	
51900306	 Italy		•	•	•	•	
51900448	 France		•	•	•	•	
51900449	 Australia		•	•	•	•	
51900481	 Denmark		•	•	•	•	
51900771	 Bulgaria, Czech Republic, Slovakia, Poland		•	•	•	•	
51900900	 China		•	•	•	•	

## Stand Options

We recommend ordering a base stand to ensure a robust and stable installation of the BSC. All of our base stands have been tested with our units for stability and functionality. Choose between a fixed working height, manually adjustable working height, or electrically adjustable working height.

Please consider the total height of the room when choosing the right working height. Footrest and castor options are available for added convenience.

		Herasafe KSP / Maxisafe 2020	Herasafe KS / Safe 2020	MSC-Advantage	Factory Installed	Field Installed
<b>Floor Stand (Height of 680 mm)</b>						
50116441	Floor stand 0.9 m. Provides work height of 750 mm		•	•		•
50109309	Floor stand 1.2 m. Provides work height of 750 mm		•	•		•
50116442	Floor stand 1.5 m. Provides work height of 750 mm		•	•		•
50109311	Floor stand 1.8 m. Provides work height of 750 mm		•	•		•
<b>Adjustable Floor Stand (Height of 680 – 880 mm)</b>						
50116443	Adjustable floor stand 0.9 m. Provides variable work height of 750 mm – 950 mm in 50 mm adjustable increments	Included with cabinet	•	•		•
50109312	Adjustable floor stand 1.2 m. Provides variable work height of 750 mm – 950 mm in 50 mm adjustable increments	Included with cabinet	•	•		•
50116444	Adjustable floor stand 1.5 m. Provides variable work height of 750 mm – 950 mm in 50 mm adjustable increments	Included with cabinet	•	•		•
50109313	Adjustable floor stand 1.8 m. Provides variable work height of 750 mm – 950 mm in 50 mm adjustable increments	Included with cabinet	•	•		•
<b>Electronic Height Adjustable Floor Stand, with Programmable Remote Control (Height of 680 – 880 mm)</b>						
50117449	Electrically adjustable floor stand for 0.9. 750 mm to 950 mm plus three memory-set heights		•	•		•
50109314	Electrically adjustable floor stand for 1.2. 750 mm to 950 mm plus three memory-set heights		•	•		•
50117450	Electrically adjustable floor stand for 1.5. 750 mm to 950 mm plus three memory-set heights		•	•		•
50109325	Electrically adjustable floor stand for 1.8. 750 mm to 950 mm plus three memory-set heights		•	•		•
<b>Foot Rest Bar, for Non Electronic Floor Stand</b>						
50051982	KFR 09 foot rest bar for non-electrical stands 0.9 m		•	•		•
50051983	KFR 12 foot rest bar for non-electrical stands 1.2 m		•	•		•
50051984	KFR 15 foot rest bar for non-electrical stands 1.5 m		•	•		•
50051985	KFR 18 foot rest bar for non-electrical stands 1.8 m		•	•		•
<b>Castors for Fixed Stands Only</b>						
50109977	Castors. Provides work height of 850 mm		•	•		•



Manually adjustable stand



Electric adjustable stand



Foot rest bar



Castors



## Work Surface Options

You have the option to fully customize your new BSC to accommodate any work task. The standard cabinet includes our stainless steel segmented worktray for easy removal, autoclaving, and cleaning under the work surface. To customize your work area, order the part number to remove the standard worktray and configure the cabinet as desired, including the option to upgrade your MSC-Advantage BSC to a 316 stainless steel (SS) work surface.

		Herasafe KSP / Maxisafe 2020	Herasafe KS / Safe 2020	MSC-Advantage	Factory Installed	Field Installed
<b>Removal of Segmented Work Surfaces (must be applied before work surfaces are changed)</b>						
51900651	Without 316 SS segmented 300 mm tabletop modules for 0.9 m BSC	•	•		•	
51900652	Without 316 SS segmented 300 mm tabletop modules for 1.2 m BSC	•	•		•	
51900653	Without 316 SS segmented 300 mm tabletop modules for 1.5 m BSC	•	•		•	
51900654	Without 316 SS segmented 300 mm tabletop modules for 1.8 m BSC	•	•		•	
<b>Removal of Segmented Work Surfaces (must be applied before work surfaces are changed)</b>						
51901025	Without 304 SS segmented 300 mm tabletop modules for 0.9 m BSC			•	•	
51900915	Without 304 SS segmented 300 mm tabletop modules for 1.2 m BSC			•	•	
51901027	Without 304 SS segmented 300 mm tabletop modules for 1.5 m BSC			•	•	
51900916	Without 304 SS segmented 300 mm tabletop modules for 1.8 m BSC			•	•	
<b>Work Surface Options</b>						
50073666	KAM15 work surface section 150 mm width. (316 SS)	•	•	•	•	•
50072685	KAM30 work surface section 300 mm width. (316 SS)	•	•	•	•	•
50073667	KAM60 work surface section 600 mm width. (316 SS)	•	•	•	•	•
50076398	KAM90 work surface section 900 mm width. (316 SS)	•	•	•	•	•
50082970	KAM120 work surface section 1200 mm width. (316 SS)	•	•	•	•	•
50122210	KAM150 work surface section 1500 mm width. (316 SS)	•	•	•	•	•
50085281	KAM180 work surface section 1800 mm width. (316 SS)	•	•	•	•	•
50073668	KAML60 lowered work surface section 600 mm width. (316 SS)	•	•	•	•	•
50073669	KAML90 lowered work surface section 900 mm width. (316 SS)	•	•	•	•	•
50073670	KAML120 lowered work surface section 1200 mm width. (316 SS)	•	•	•	•	•
50073671	KAML150 lowered work surface section 1500 mm width. (316 SS)	•	•	•	•	•
50078750	KAML180 lowered work surface section 1800 mm width. (316 SS)	•	•	•	•	•
50073757	KAMW30 vibration damped work surface section 300 mm width. (316 SS). For weighing equipment/microscopy equipment		•	•	•	•
50084339	WP3 vibration damped granite block section 300 mm width. For weighing equipment /microscopy equipment	•			•	•
50076162	KAMW60 vibration damped work surface section 600 mm width. (316 SS). For weighing equipment/microscopy equipment		•	•	•	•
50084350	WP6 vibration damped granite block section 600 mm width. For weighing equipment/microscopy equipment	•			•	•
50078875	KAMS 30 Minisink module (3 Litres) with lid. Requires drain valve (51900641) to be fitted	•	•		•	•
51900641	Drain valve (fitted under work surface)	•	•		•	
50073663	Replacement armrests KAS 30 set of 2 arm rests (316 SS)	•	•	•		•



500788575 optional  
Minisink module

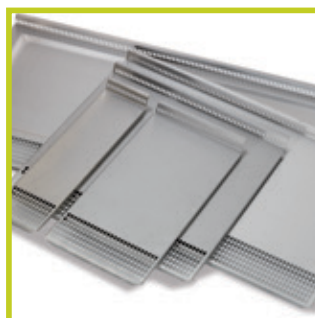

Optional 316 stainless steel  
work surface configurations

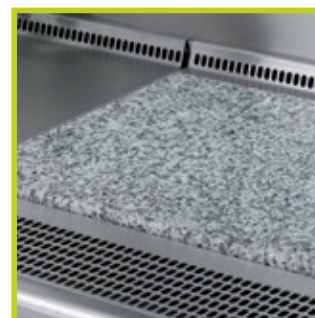

50076162 optional 600 mm  
vibration dampened granite block

## Additional Filter Options

Additional exhaust HEPA filters (AEF) can be fitted to the top of the BSC to provide 99.99999975% cumulative exhaust filtration. Please note that AEF filters are not a requirement for recirculating BSCs, even in the UK, where BS5726 has been superseded by EN 12469, since 2000. Additional exhaust carbon filters can be fitted on top of the BSC or in place of the underbench filters, but should only to be used for traces of solvents being used as an adjunct to microbiological study.

		Herasafe KSP / Maxisafe 2020	Herasafe KS / Safe 2020	MSC-Advantage	Factory Installed	Field Installed
<b>Additional HEPA Filter Options for All Models</b>						
51900657	Factory fitted additional exhaust HEPA filter		•	•	•	
50078857	Additional exhaust HEPA filter for retrofit to 0.9 m cabinets. Fittings included		•			•
50073772	Additional exhaust HEPA filter for retrofit to 1.2 / 1.5 m cabinets. Fittings included		•			•
50078856	Additional exhaust HEPA filter for retrofit to 1.8 m cabinets. Fittings included		•			•
50109987	Additional exhaust HEPA filter for retrofit to 0.9 / 1.2 / 1.5 m cabinets. Fittings included			•		•
50109988	Additional exhaust HEPA filter for retrofit to 1.8 m cabinets. Fittings included			•		•
<b>Additional Carbon-Enhanced Filter Options for All Models</b>						
51900658	Factory fitted additional exhaust carbon filter		•	•	•	
50078783	Additional activated carbon filter for retrofit to 0.9 m cabinets. Fittings included		•			•
50073773	Additional activated carbon filter for retrofit to 1.2 / 1.5 m cabinets. Fittings included		•			•
50078784	Additional activated carbon filter for retrofit to 1.8 m cabinets. Fittings included		•			•
50109989	Additional activated carbon filter for retrofit to 0.9 / 1.2 / 1.5 m cabinets. Fittings included			•		•
50110305	Additional activated carbon filter for retrofit to 1.8 m cabinets. Fittings included			•		•
51900781	Activated carbon-prefilter set for KSP 9 / Maxisafe 2020 0.9 m	•			•	
51900782	Activated carbon-prefilter set for KSP 12 / Maxisafe 2020 1.2 m	•			•	
51900783	Activated carbon-prefilter set for KSP 15 / Maxisafe 2020 1.5 m	•			•	
51900784	Activated carbon-prefilter set for KSP 18 / Maxisafe 2020 1.8 m	•			•	
<b>Grid Filters</b>						
50076846	Grid filter set, G1 acc. To EN 779 (5pcs) 0.9, 1.2 m	•	•			•
50076921	Grid filter Set, G1 acc. To EN 779 (5pcs) 1.5, 1.8 m	•	•			•



Additional exhaust HEPA filter



Activated carbon filter  
for triple-filter cabinets

## UV Options

The optional UV timer function is available to help preserve bulb life. The light is programmable from 30 minutes to 24 hours in 30-minute increments. It is programmed one time, and then stores this information for future use. This convenient feature ensures that the bulbs will not require excessive replacement due to premature and unnecessary degradation.

### Cross Beam UV Disinfection

We offer a number of UV options, as detailed in the below part numbers. These include the powerful cross beam UV disinfection system which is installed in both side walls and illuminates the entire working area without causing shadows. This ensures thorough disinfection of the complete chamber for maximum sample protection (see diagram).



High performance UV-C irradiators, built vertically in the left and right sides, ensure high disinfections efficiency and minimize shaded areas.

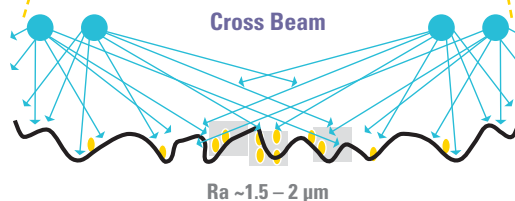

	Herasafe KSP / Maxisafe 2020	Herasafe KS / Safe 2020	MSC-Advantage	Factory Installed	Field Installed
--	---------------------------------	----------------------------	---------------	----------------------	--------------------

#### UV Options

51900642	Cross beam UV-C light option in side walls (comes with protective cover)	•	•	•	
50073962	Rear wall UV light – hanging from rear wall (may not be used with 0.9 m cabinet), must be ordered with UV-socket 51900643 (or 50109996) and hanging bar 50073944	•	•		•
50048696	Free standing mobile UV-C irradiator for set up in the work area only. UV-C connection is required 51900643 (or 50109996)	•	•		•
51900643	UV-C connection – required when using mobile (50073962) or rear wall (50048696) UV-C irradiators	•	•	•	
50109996	UV-C connection for retrofitting – required when using mobile (50073962) or rear wall (50048696) UV-C irradiators	•	•		•
50109994	UV light option, field installed				•
51900912	UV light option, factory installed			•	

### Robust Safety Glass

All Thermo Scientific BSC's come with safety glass which has been tested internally to show that the UV light of 254 nm wavelength does not pass through (see graph). As all UV options are interlocked with the window, this ensures your safety during a UV disinfection cycle.

Transmission SIGLA Mehrscheibensicherheitsglas  
Laminated Safety Glass

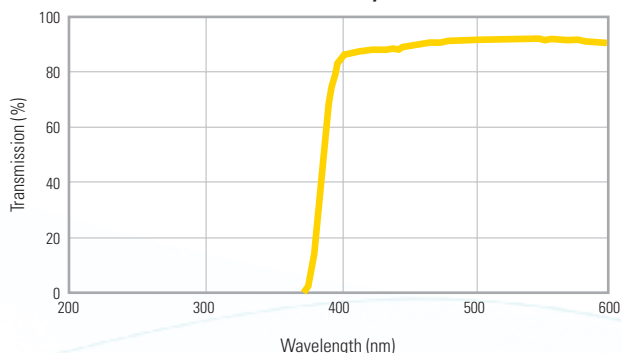

## Media Valves

Our standard BSCs feature a dual-side wall negative pressure design which allows the user to install service valves through the side access ports. We also offer factory-installed piping options on our premium units to connect utilities to the top of the BSC to conserve right to left exterior footprint.

		Herasafe KSP / Maxisafe 2020	Herasafe KS / Safe 2020	MSC-Advantage	Factory Installed	Field Installed
<b>Side Wall Service Taps / Media Valves / Lead Throughs</b>						
50044678	Vacuum tap G3/8 connection (grey) with long neck for installation in side walls	•	•	•		•
50044679	Water tap G3/8 connection (black) with long neck for installation in side walls	•	•	•		•
50045959	Non-combustible gas G3/8 gas connection (green) with long neck for installation in side walls	•	•	•		•
50046015	Combustible gas G3/8 connection (yellow) with long neck for installation in side walls	•	•	•		•
50059017	Lead through for hose connections, long neck type for side wall use. Suitable for 10 – 13 mm inner diameter hose	•	•	•		•
50076408	Lead through for hose connections, long neck type for side wall use. Suitable for 3 mm inner diameter hose	•	•	•		•
<b>Rear Wall Media Connections (connection for media taps will be made at top of cabinet – must be ordered with rear wall valves)</b>						
51900649	Three media taps mounted on left hand side of rear wall	•	•		•	
51900711	Three media taps mounted on right hand side of rear wall	•	•		•	
51900722	Six media taps. Three taps mounted on both left and right hand side of rear wall	•	•		•	
<b>Rear Wall Service Taps / Media Valves (supplies are plumbed in above BSC)</b>						
50068232	Vacuum tap G3/8 connection (grey) with short neck for installation in rear wall	•	•			•
50068233	Water tap G3/8 connection (black) with short neck for installation in rear wall	•	•			•
50068234	Non-combustible gas G3/8 connection (green) with short neck for installation in rear wall	•	•			•
50068235	Combustible gas G3/8 connection (yellow) with short neck for installation in rear wall	•	•			•
<b>Solenoid Valve (should only be quoted with combustible gas valves)*</b>						
50074905	Solenoid valve for interlocking with tap for combustible gas G3/8 connection	•	•	•		•



Side wall service and rear wall media taps



Media taps mounted on rear wall

\* Check with local authorities whether or not this feature is required for your institution. This option ensures that gas is disconnected in the event of a power failure. If a solenoid valve is already part of the gas supply, this is not required.

### Exhaust Duct Connection Kits

HEPA filters do a great job of trapping particles and biohazards, but they do not trap gases and toxic chemicals that may be used as an adjunct to microbiological studies. In these applications, it is important to select an exhaust duct transition to route exhaust air out of the laboratory to the external environment. We offer two different connections that can be installed in three different ways, depending upon facility requirements.

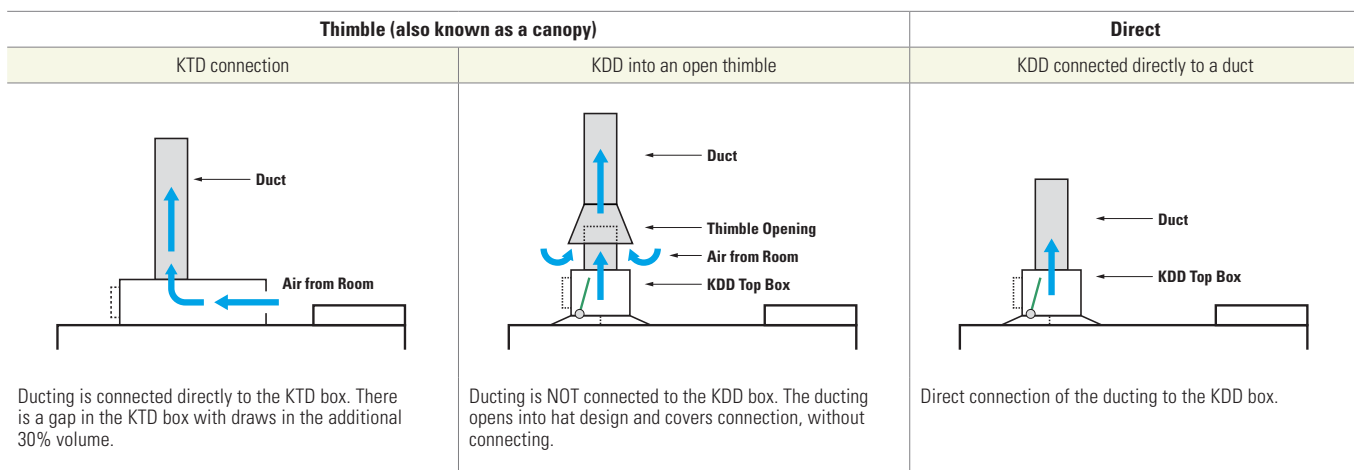

	Herasafe KSP / Maxisafe 2020	Herasafe KS / Safe 2020	MSC-Advantage	Factory Installed	Field Installed
--	------------------------------	-------------------------	---------------	-------------------	-----------------

#### Exhaust Duct Connection Kits and Fumigation Accessories

	Herasafe KSP / Maxisafe 2020	Herasafe KS / Safe 2020	MSC-Advantage	Factory Installed	Field Installed
50109984	Thimble duct exhaust transition (KTD). Connection diameter 200 mm. For 0.9, 1.2, 1.5 m BSC		•		•
50109985	Thimble duct exhaust transition (KTD). Connection diameter 200 mm. For 1.8 m BSC		•		•
50109981	Direct duct exhaust transition with anti blowback valve (KDD). Connection diameter 200 mm. For 0.9, 1.2, 1.5 m BSC		•		•
50109982	Direct duct exhaust transition with anti blowback valve (KDD). Connection diameter 200 mm. For 1.8 m BSC		•		•
50078796	Thimble duct exhaust transition (KTD). Connection diameter 200 mm. For 0.9 m BSC	•	•		•
50073770	Thimble duct exhaust transition (KTD). Connection diameter 200 mm. For 1.2 and 1.5 m BSC	•	•		•
50078795	Thimble duct exhaust transition (KTD). Connection diameter 200 mm. For 1.8 m BSC	•	•		•
50078791	Direct duct exhaust transition with anti blowback valve (KDD). Connection diameter 200 mm. For 0.9 m BSC	•	•		•
50073771	Direct duct exhaust transition with anti blowback valve (KDD). Connection diameter 200 mm. For 1.2 and 1.5 m BSC	•	•		•
50078790	Direct duct exhaust transition with anti blowback valve (KDD). Connection diameter 200 mm. For 1.8 m BSC	•	•		•



Direct duct exhaust transition (KDD)

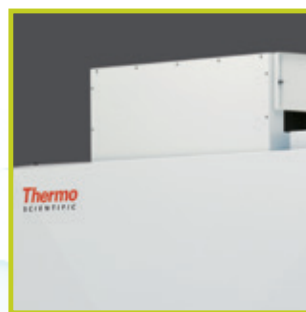

Thimble duct exhaust transition (KTD)

All duct work, shown above in grey, is not sold, manufactured or installed under Thermo Fisher Scientific. However, as a global manufacturer of biological safety cabinets, we offer advice and consultation on the installation of exhaust duct systems for Thermo Scientific biological safety cabinets.

## Sealing Kits for Fumigation

In addition to surface wipe downs within the BSC work area, it may be necessary to fumigate the potentially contaminated interior plenums of the unit. Fumigation to access biologically contaminated BSC plenums is most often done using formalin, paraformaldehyde, or hydrogen peroxide vapor. With these and most other methods it is necessary to first seal off the unit, then introduce the fumigating agent, allow appropriate time for the agent to be effective, then neutralize and/or release the fumigating agent. The fumigating agent and method selected is usually specified by local regulations or institution guidelines based on the type of contamination. The kits and accessories below facilitate the fumigation process.

		Herasafe KSP / Maxisafe 2020	Herasafe KS / Safe 2020	MSC-Advantage	Factory Installed	Field Installed
<b>Complete Kits</b>						
50132757	H <sub>2</sub> O <sub>2</sub> adjustable sealing kit (ASK) includes adjustable top box and front window cover. Fits all sizes of BSC. (includes outlet and inlet connections for STERIS™)	•	•	•		•
<b>Inlets Only</b>						
50135768	H <sub>2</sub> O <sub>2</sub> front window sealing plate. This seals the front aperture, and has a STERIS connector.	•	•	•		•
50137105	STERIS H <sub>2</sub> O <sub>2</sub> Camlock inlet connector. Fits into one access port left or right side of the BSC.	•	•	•		•
50137107	Bioquell™ H <sub>2</sub> O <sub>2</sub> Camlock inlet connector (includes sample connector). Uses two access ports on side of BSC.	•	•	•		•
<b>Outlets Only</b>						
50137106	STERIS or Bioquell Camlock outlet connector (for connection to top box or duct connectors)	•	•	•		•
50135767	H <sub>2</sub> O <sub>2</sub> adjustable top box for Thermo Scientific BSC with outlet connector (STERIS or Bioquell)	•	•	•		•
<b>Others</b>						
50114036	Fumigation window sealing kit for MSC-Advantage/1300 series only			•		•
50109998	Disinfection tent for formaldehyde disinfection	•	•	•		•

## H<sub>2</sub>O<sub>2</sub> Fumigation Accessories

When fumigating a biological safety cabinet using H<sub>2</sub>O<sub>2</sub>, there are many accessories available. When choosing accessories there are basic questions to consider.

- Is the biological safety cabinet recirculating or ducted (with a KDD connector)? See the chart below for guidance.
- Is the inlet of the H<sub>2</sub>O<sub>2</sub> generator connected via a removable front sealing gasket (STERIS only) or through a fixed side connector (STERIS or Bioquell)? See chart below for guidance.

	Recirculating		Ducted	
	Side Connection	Front Connection	Side Connection	Front Connection
STERIS	50137105 (one per cabinet) 50135767 (one required)	50132757 (one required)	50137105 (one per cabinet) 50137106 (one per cabinet)	50135768 (one required) 50137106 (one per cabinet)
Bioquell	50137107 (one per cabinet) 50135767 (one required)	Not available	50137107 (one per cabinet) 50137106 (one per cabinet)	Not available



50114036 fumigation window sealing kit



H<sub>2</sub>O<sub>2</sub> side wall connections



H<sub>2</sub>O<sub>2</sub> adjustable sealing kit (ASK)

## Other Options and Accessories

For specialized applications, these are additional standard options and accessories that may be considered.

		Herasafe KSP / Maxisafe 2020	Herasafe KS / Safe 2020	MSC-Advantage	Factory Installed	Field Installed
<b>Rear Wall and Side Wall Modifications (KS / KSP / Safe / Maxisafe)</b>						
51900648	Lacquer coated inside work area rear wall, grey-white	•	•		•	
51900644	All models stainless steel left hand side wall	•	•		•	
51900645	All models stainless steel right hand side wall	•	•		•	
51900646	All models polycarbonate left hand side wall	•	•		•	
51900647	All models polycarbonate right hand side wall	•	•		•	
<b>Battery Back Up</b>						
51900786	Battery-back-up for motorized front window (allows closure of window in the event of a power outage)	•	•		•	
<b>Remote Control and Accessories</b>						
50075090	Spare remote control set	•	•			•
50075089	Spare holder for remote control	•	•			•
<b>Water-Cooled Exhaust Systems*</b>						
50078873	Exhaust cooling device for 1.2 m and 1.5 m	•	•			•
50078874	Exhaust cooling device for 1.8 m	•	•			•
<b>Magnahelic Pressure Gauge</b>						
51900650	Magnahelic pressure gauge	•	•		•	

\* must be connected to laboratory water supply

## User Convenience Options

We offer unique customer installed accessories to help organize your workspace and free up valuable space inside and around the BSC.

		Herasafe KSP / Maxisafe 2020	Herasafe KS / Safe 2020	MSC-Advantage	Factory Installed	Field Installed
<b>Convenience Equipment</b>						
50073943	Hanging bar with 6 hooks. For 0.9 m BSC	•	•			•
50073944	Hanging bar with 6 hooks. For use with 1.2, 1.5, 1.8 m BSC	•	•			•
50078900	Utility basket with hanging bar kit	•	•	•		•
50078901	Two utility baskets with hanging bar kit	•	•	•		•
50125639	Hanging bar with 6 hooks for MSC-Advantage 0.9 m			•		•
50109979	Hanging bar with 6 hooks for MSC-Advantage 1.2, 1.5, 1.8 m			•		•
ERG-CR-2330	Ergolign clean room saddle stool	•	•	•		•
<b>NEW! SmartPort Accessories</b>						
50128685	Floor stand hanging shelf. Compatible with fixed height and manual adjustable height base stands	•	•	•		•
50128681	Replacement SmartPort grommets (set of 4)			•		•
50128703	Rear wall clips for securing tubing/cords (set of 6)	•	•	•		•



SmartPort floor stand hanging shelf



Utility basket with hanging bar kit

# high performance with optimized efficiency, safety and functionality

## Thermo Scientific Heraguard ECO Clean Benches

NEW Heraguard™ ECO clean benches are ideal for laboratory applications where sample protection is required. Due to DC motors, Heraguard ECO clean benches use less energy to operate so there is less heat emitted into the lab.\*

### Heraguard ECO clean benches provide:

- Sample protection
- Clean air conditions that can be validated
- Ease of use

### Variety of sizes

Clean benches are available with interior widths of 900, 1200, 1500 and 1800 mm, and are offered in two different working heights:

- Standard work space height 650 mm
- Extra work space height 950 mm

### All-round vision

The side windows increase the available light inside the work area and support a comfortable work environment.

### UV disinfection (optional)

A UV disinfection light can be fitted into the top of the work space to disinfect the worktop.

### Transparent hinged wind screen (optional)

Protects the user against the dry purified air flow. The wind screen is folded under the light housing and can be flipped down for use.

### SmartPort™ convenience

Clean and safe routing for vacuum tubing and cables through the side of the clean bench improves organization and work efficiency.

### Modular side windows

The side windows are made of single pane safety glass with an access port for tubing or a media tap. Optionally, a lacquered sheet steel plate with three holes can be used.

### Prefilter

The prefilter on the intake side can be changed by hand, without the need for tools. Prefilter exchange is made economical and easy.

### Intuitive control panel

Displays safety and performance data.

### Easy HEPA filter exchange

The HEPA filter is easily removed from the front – a simple process that does not involve any disassembly or removal of equipment from the wall. This saves time during service visits.

### Choice of work tops

Standard melamine work tops or optional stainless steel tops are available for different applications and individual work space designs.

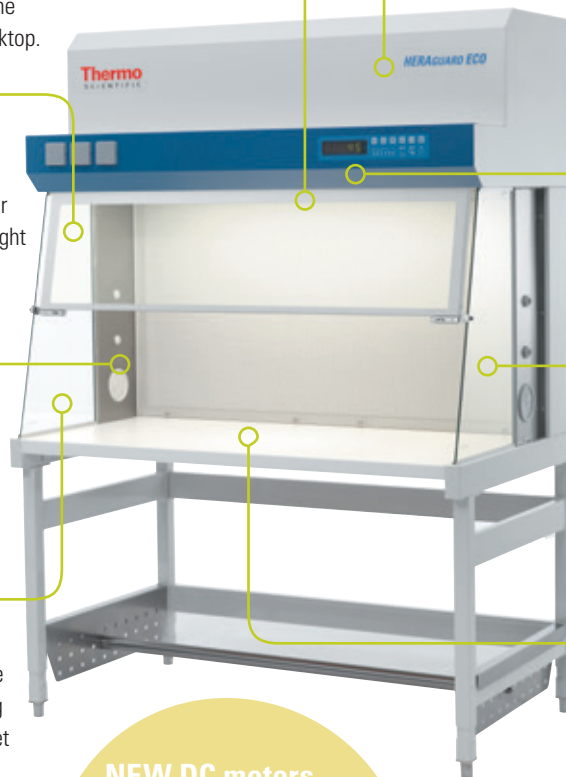

**NEW DC motors  
Now available with  
DC motors which offer  
over 60% lower energy  
consumption compared  
to previous model  
(based on 1.2m model)**

\* Based on data from internal testing and The University of Michigan Field Study, published in American Biotechnology Laboratory.



# Thermo Scientific Heraguard ECO Clean Benches



Model		ECO 0.9	ECO 1.2	ECO 1.5	ECO 1.8	ECO 1.8/95
<b>Ordering Information</b>		51029701	51029702	51029703	51029704	51029705
<b>Dimensions</b>						
Exterior dimensions W x H x D	mm	1000 x 1170 x 810	1300 x 1170 x 810	1600 x 1170 x 810	1900 x 1170 x 810	1900 x 1475 x 1010
Interior dimensions W x H x D	mm	920 x 645 x 585	1220 x 645 x 585	1520 x 645 x 585	1820 x 645 x 585	1820 x 950 x 785
Usable work area <sup>1</sup> W x H x D	mm	920 x 645 x 585	1220 x 645 x 585	1520 x 645 x 585	1820 x 645 x 585	1820 x 950 x 785
Shipping dimensions <sup>2</sup> W x H x D	mm	1130 x 1320 x 980	1430 x 1320 x 980	1730 x 1320 x 980	2030 x 1320 x 980	2030 x 1620 x 1180
<b>Weight</b>						
Net weight	kg	110	125	140	160	170
Shipping weight <sup>2</sup>	kg	135	150	180	200	220
Max. load capacity of work surface	kg	30	30	30	30	30
<b>Electrical Data</b>						
Voltage	V	230				
Frequency	Hz	50 / 60				
Protection class		I				
Overvoltage category		II				
IP protection system		IP 20				
<b>Compliance</b>						
Agency		GOST				
CE		2006/95/EC; 2004/108/EC; 2011/65/EC; 2006/121/EC				
Standards		EN 61010-1:2011; EN 61326:2006				
Prefilter		Type (EN779) G 3 dust filter, filtering efficiency: coarse - medium				
<b>Performance Specifications</b>						
Power consumption	W	270	270	550	550	550
Heat output	BTU/hr	920	920	1840	1840	1840
Air velocity	m/s	0.45 +/- 20% (reduced flow = 0.23 +/- 20%, all models)				0.40 +/- 20%
Lighting intensity	lx	> 1000				
Noise pressure level	dB(A)	<55		<60		
Minimum clearance from room ceiling	mm	150				
Side windows		Tempered safety glass				
Tabletop		White melamine; stainless steel optional				
Receptacles <sup>3</sup>		3				
Service valves		Up to 2 may be installed through access ports (1 left, 1 right)				

1 With optional work surface depth

2 Export packaging dimensions and weight upon request

3 The receptacles have a load capacity of up to 5 A and are protected with T 5 A fuses. When all receptacles are in use simultaneously they must not exceed the maximum total load capacity of 5 A

Heraguard ECO Clean Benches and Accessories		Factory Installed	Field Installed
51029701	Heraguard ECO 0.9 width 1000mm, internal width ~920mm, weight ~90kg 230V/50HZ		
51029702	Heraguard ECO 1.2 width 1300mm, internal width ~1220mm, weight ~120kg 230V/50HZ		
51029703	Heraguard ECO 1.5 width 1600mm, internal width ~1520mm, weight ~140kg 230V/50HZ		
51029704	Heraguard ECO 1.8 width 1900mm, internal width ~1820mm, weight ~150kg 230V/50HZ		
51029705	Heraguard ECO 1.8/95 width 1900mm, internal width 1820mm, weight 220kg 230V/50HZ		

**Country Configurations**

51900300	Switzerland	•	
51900303	UK	•	
51900306	Italy	•	
51900448	France	•	
51900449	Australia	•	
51900481	Denmark	•	
51900900	China	•	

**Floor Stand (Height of 680 mm)**

50116441	Floor stand 0.9 m. Provides ECO work height of 760 mm		•
50109309	Floor stand 1.2 m. Provides ECO work height of 760 mm		•
50116442	Floor stand 1.5 m. Provides ECO work height of 760 mm		•
50109311	Floor stand 1.8 m. Provides ECO work height of 760 mm		•

**Adjustable Floor Stand (Height of 680 - 880mm)**

50116443	Adjustable floor stand 0.9 m. Provides variable ECO work height of 760 mm - 960 mm in 50 mm adjustable increments		•
50109312	Adjustable floor stand 1.2 m. Provides variable ECO work height of 760 mm - 960 mm in 50 mm adjustable increments		•
50116444	Adjustable floor stand 1.5 m. Provides variable ECO work height of 760 mm - 960 mm in 50 mm adjustable increments		•
50109313	Adjustable floor stand 1.8 m. Provides variable ECO work height of 760 mm - 960 mm in 50 mm adjustable increments		•

**Foot Rest Bar, for Non Electronic Floor Stand**

50051982	KFR 09 foot rest bar for non-electrical stands 0.9 m		•
50051983	KFR 12 foot rest bar for non-electrical stands 1.2 m		•
50051984	KFR 15 foot rest bar for non-electrical stands 1.5 m		•
50051985	KFR 18 foot rest bar for non-electrical stands 1.8 m		•

**Castors for Fixed and Manually Adjustable Stands**

50109977	Castors. Provides work height of 860 mm		•
----------	---	--	---



Control panel



Left hand glass with metal sheet and two service valves

**Heraguard ECO Clean Benches and Accessories** **Factory Installed** **Field Installed**

**Media Valves**

50044678	Vacuum tap G3/8 connection (grey) with long neck for installation in side walls		•
50044679	Water tap G3/8 connection (black) with long neck for installation in side walls		•
50045959	Non-combustible gas G3/8 gas connection (green) with long neck for installation in side walls		•
50046015	Combustible gas G3/8 connection (yellow) with long neck for installation inside walls		•
50059017	Lead through for hose connection for side wall use. Suitable for 10 – 13 mm inner diameter hose		•
50076408	Lead through for hose connection for side wall use. Suitable for 3 mm inner diameter hose.		•

**Solenoid Valve (should only be quoted with combustible gas valves)\***

50074905	Solenoid valve for use with tap for flammable gas cylinders G3/8 connection		•
----------	---	--	---

**Stainless Steel Work Surface Wraps**

51901074	Stainless steel work surface for HERAGuard ECO 9 width 900mm, depth 580mm	•	
51901075	Stainless steel work surface for HERAGuard ECO 1.2 width 1200mm, depth 580mm	•	
51901076	Stainless steel work surface for HERAGuard ECO 1.5 width 1500mm, depth 580mm	•	
51901077	Stainless steel work surface for HERAGuard ECO 1.8 width 1800mm, depth 580mm	•	
51901078	Stainless steel work surface for HERAGuard ECO 1.8/95 width 1800mm, depth 780mm	•	

**Side Window Modifications**

51901071	Left hand glass with metal sheet and 3 media valve holes for models: HERAGuard ECO 0.9, 1.2, 1.5, 1.8, 1.8/95	•	•
51901072	Right hand glass with metal sheet and 3 media valve holes for models: HERAGuard ECO 9, 12, 15, 18 and ECO 18/95	•	•

**UV Options**

51901073	UV Option, factory installed, comes with UV-resistant night cover	•	
50140092	Retrofit kit UV-radiator HERAGuard ECO 0.9		•
50140093	Retrofit kit UV-radiator HERAGuard ECO 1.2		•
50140094	Retrofit kit UV-radiator HERAGuard ECO 1.5		•
50140095	Retrofit kit UV-radiator HERAGuard ECO 1.8		•
50140096	Retrofit Kit UV-Radiator HERAGuard ECO 1.8/95		•

**Wind Screen Protection Kits**

50052208	Wind screen protection kit, complete with hinges to fit the control unit for HERAGuard ECO 0.9	•	
50052460	Wind screen protection kit, complete with hinges to fit the control unit for HERAGuard ECO 1.2	•	
50052461	Wind screen protection kit, complete with hinges to fit the control unit for HERAGuard ECO 1.5	•	
50052462	Wind screen protection kit, complete with hinges to fit the control unit for HERAGuard ECO 1.8	•	

**UV-Resistant Night Covers**

50139417	UV-resistant night cover for HERAGuard ECO 0.9		•
50139418	UV-resistant night cover for HERAGuard ECO 1.2		•
50139419	UV-resistant night cover for HERAGuard ECO 1.5		•
50139420	UV-resistant night cover for HERAGuard ECO 1.8		•
50139421	UV-resistant night cover for HERAGuard ECO 1.8/95		•

**General Accessories**

50073943	Hanging bar 700mm with set of 6 hooks for HERAGuard ECO 0.9		•
50073944	Hanging bar 1000mm with set of 10 hooks for HERAGuard ECO 1.2 - 1.8/95		•



UV-resistant night cover



Wind screen protection kit

\* Check with local authorities whether or not this feature is required for your institution. This option ensures that gas is disconnected in the event of a power failure.

# exactly what you need to meet any application challenge



## Redefining pipetting productivity

Trust the Thermo Scientific S1 Pipet Filler to deliver everything you need to stay productive in the lab: faster performance, advanced speed controls and longer battery life. The portable lightweight S1 Pipet Filler is designed for use with either glass or plastic serological pipets. It offers effective streamlined pipetting performance with maximum pipetting comfort.

[thermoscientific.com/handleanything](http://thermoscientific.com/handleanything)

## Discovery thrives in a culture of confidence

More scientists worldwide trust their valuable cultures to Thermo Scientific CO<sub>2</sub> incubators than any other brand. They depend on proven reliability, exceptional contamination prevention and optimal growing conditions. Delivered with innovative features like HEPA air filtration that surrounds cells with clean room-like air quality and a choice of 100% pure copper or polished stainless steel interior surfaces. Plus a high-temperature decontamination function that eliminates the need for autoclaving and handling components. The inside story is simple: our CO<sub>2</sub> incubators let you culture with complete confidence. Day after day. Year after year.

[thermoscientific.com/co2incubator](http://thermoscientific.com/co2incubator)



To learn more visit [thermoscientific.com/bsc](http://thermoscientific.com/bsc)

© 2013 Thermo Fisher Scientific Inc. All rights reserved. STERIS is a registered trademark of STERIS. Bioquell is a registered trademark of Bioquell. All other trademarks are the property of Thermo Fisher Scientific Inc. and its subsidiaries. Specifications, terms and pricing are subject to change. Not all products are available in all countries. Please consult your local sales representative for details.

**Australia** +61 39757 4300

**Austria** +43 1 801 40 0

**Belgium** +32 53 73 42 41

**China** +86 21 6865 4588 or  
+86 10 8419 3588

**France** +33 2 2803 2180

**Germany national toll free** 0800 1 536 376

**Germany international** +49 6184 90 6000

**India toll free** 1800 22 8374

**India** +91 22 6716 2200

**Italy** +39 02 95059 552

**Japan** +81 45 453 9220

**Netherlands** +31 76 579 55 55

**New Zealand** +64 9 980 6700

**Nordic/Baltic/CIS countries**

+358 9 329 10200

**Russia** +7 812 703 42 15

**Spain/Portugal** +34 93 223 09 18

**Switzerland** +41 44 454 12 22

**UK/Ireland** +44 870 609 9203

**USA/Canada** +1 866 984 3766

**Other Asian countries** +852 2885 4613

**Countries not listed** +49 6184 90 6000

**Thermo**  
SCIENTIFIC

Part of Thermo Fisher Scientific